

## **Kablo Merdiveni H 100** **Cable Ladder H 100**

### **İÇİNDEKİLER** **INDEX**

**104**

**Kablo Merdiveni**  
Cable Ladder

**105**

**90° Yatay Dönüş Modülü**  
90° Horizontal Elbow Module  
**T Dönüş Modülü**  
T Module  
**Dörtlü Bağlantı Modülü**  
+ Connection Module

**106**

**İç Bükey Dönüş Modülü**  
90° Vertical Bend - Inside  
**Dış Bükey Dönüş Modülü**  
90° Vertical Bend - Outside  
**Ek Elemanı**  
Joint Fitting

**107**

**Seviye Değişirme Elemanı**  
Level Change Unit  
**Separatör**  
Seperator  
**Merdiven Sabitleme Elemanı**  
Ladder Fixing



## Pregalvaniz Pre-Galvanized

### Kablo Merdiveni H100

#### Cable Ladder H100

Sipariş Kodu Order Code	Yükseklik Height (H) mm	Genişlik Width (A) mm	Kalınlık Thickness (T) mm	Ağırlık Weight Kg./m.
AFC-100 M 100.15	100	100	1.5	3,309
AFC-100 M 100.20	100	100	2.0	4,355
AFC-100 M 150.15	100	150	1.5	3,400
AFC-100 M 150.20	100	150	2.0	4,446
AFC-100 M 200.15	100	200	1.5	3,502
AFC-100 M 200.20	100	200	2.0	4,548
AFC-100 M 300.15	100	300	1.5	3,695
AFC-100 M 300.20	100	300	2.0	4,741
AFC-100 M 400.15	100	400	1.5	3,891
AFC-100 M 400.20	100	400	2.0	4,937
AFC-100 M 500.15	100	500	1.5	4,080
AFC-100 M 500.20	100	500	2.0	5,127
AFC-100 M 600.15	100	600	1.5	4,273
AFC-100 M 600.20	100	600	2.0	5,319

#### Örnek Sipariş :

Yükseklik / Height (H) : 100 mm  
Genişlik / Width (A) : 100 mm  
Kalınlık / Thickness (T) : 1,5 mm  
Pregalvaniz / Pre-Galvanized : PG

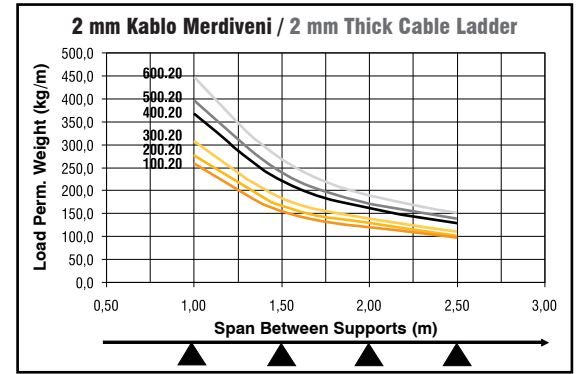
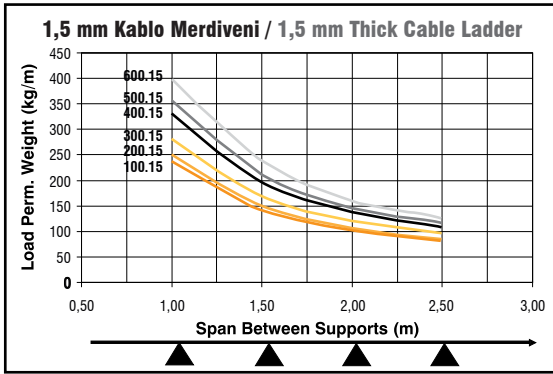
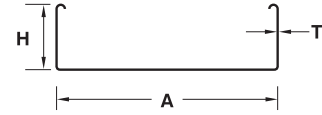
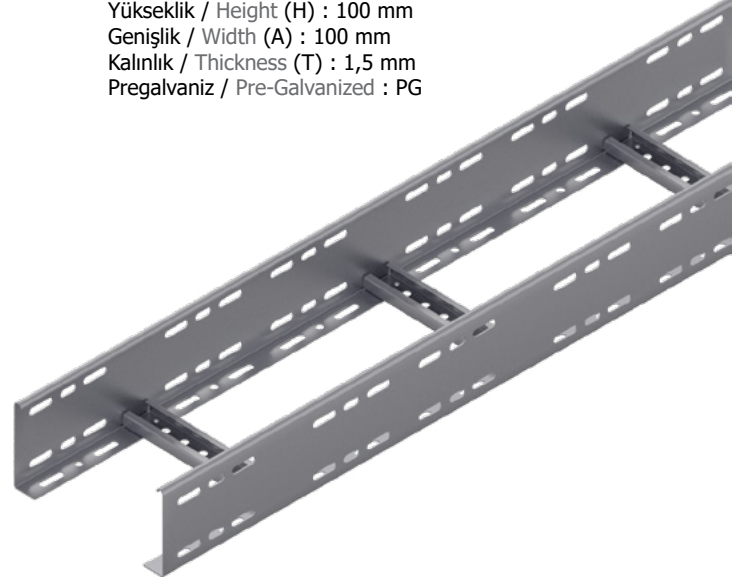

- ▶ Malzeme ağırlıkları yaklaşık değerlerdir,  $\pm$  % 10 değişim gösterebilir.  
All material weights are approximate and may vary by +/- 10%.

- ▶ Standart uzunluk 2500 ve 3000 mm'dir.  
Standard widths are available in 2500, and 3000 mm.

- ▶ Lütfen siparişlerinizde sipariş kodunu bildiriniz.  
Please order by product code.

- ▶ Farklı kalınlık ve ölçülerdeki siparişleriniz için lütfen firmamızı arayınız.  
Please contact us for your custom orders.

## 90° Yatay Dönüş Modülü

### 90° Horizontal Elbow Module

Sipariş Kodu Order Code	Yükseklik Height (H) mm	Genişlik Width (AB) mm	Kalınlık Thickness (T) mm	Ağırlık Weight Kg./Ad.
AFC-100 MK 100.15	100	100	1.5	1,582
AFC-100 MK 150.15	100	150	1.5	1,896
AFC-100 MK 200.15	100	200	1.5	2,110
AFC-100 MK 300.20	100	300	2.0	2,639
AFC-100 MK 400.20	100	400	2.0	3,993
AFC-100 MK 500.20	100	500	2.0	4,633
AFC-100 MK 600.20	100	600	2.0	5,170

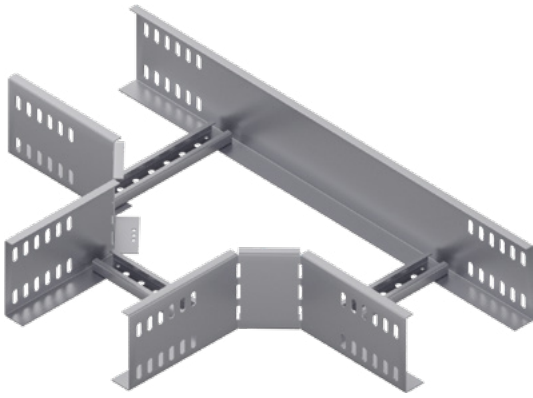
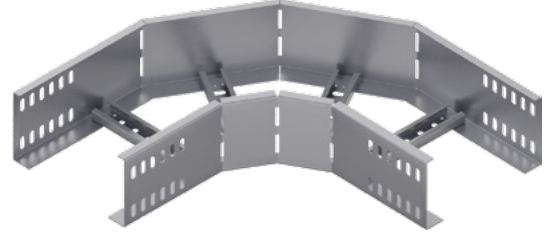

## T Dönüş Modülü

### T Module

Sipariş Kodu Order Code	Yükseklik Height (H) mm	Genişlik Width (ABC) mm	Kalınlık Thickness (T) mm	Ağırlık Weight Kg./Ad.
AFC-100 MT 100.15	100	100	1.5	2,321
AFC-100 MT 150.15	100	150	1.5	2,606
AFC-100 MT 200.15	100	200	1.5	2,843
AFC-100 MT 300.20	100	300	2.0	3,422
AFC-100 MT 400.20	100	400	2.0	4,787
AFC-100 MT 500.20	100	500	2.0	5,369
AFC-100 MT 600.20	100	600	2.0	5,954

## Dörtlü Bağlantı Modülü

### + Connection Module

Sipariş Kodu Order Code	Yükseklik Height (H) mm	Genişlik Width (ABCD) mm	Kalınlık Thickness (T) mm	Ağırlık Weight Kg./Ad.
AFC-100 MD 100.15	100	100	1.5	2,373
AFC-100 MD 150.15	100	150	1.5	2,579
AFC-100 MD 200.15	100	200	1.5	2,729
AFC-100 MD 300.20	100	300	2.0	3,091
AFC-100 MD 400.20	100	400	2.0	4,097
AFC-100 MD 500.20	100	500	2.0	4,453
AFC-100 MD 600.20	100	600	2.0	4,814

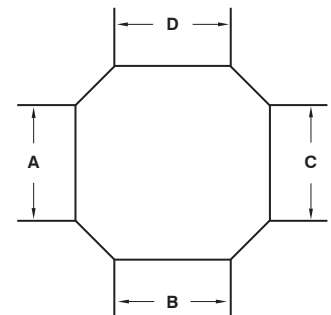
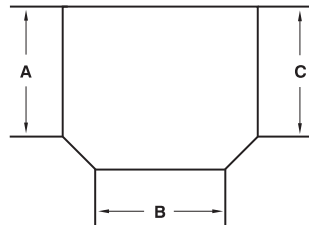
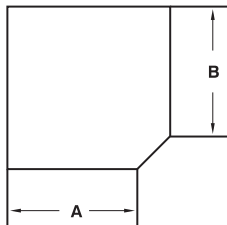
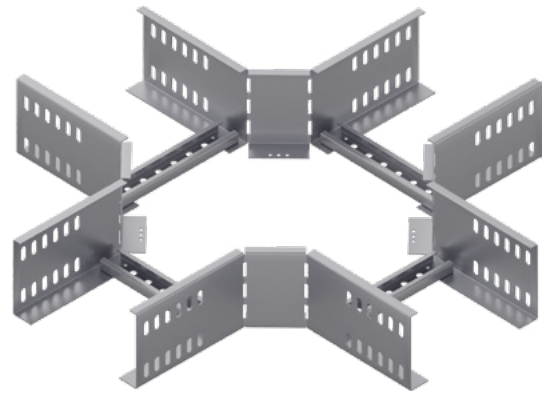



## Pregalvaniz Pre-Galvanized

### İç Bükey Dönüş Modülü

#### 90° Vertical Bend - Inside

Sipariş Kodu Order Code	Yükseklik Height (H) mm	Genişlik Width (AB) mm	Kalınlık Thickness (T) mm	Ağırlık Weight Kg./Ad.
AFC-100 MİB 100.15	100	100	1.5	2,767
AFC-100 MİB 150.15	100	150	1.5	2,873
AFC-100 MİB 200.15	100	200	1.5	2,947
AFC-100 MİB 300.15	100	300	2.0	3,128
AFC-100 MİB 400.20	100	400	2.0	3,312
AFC-100 MİB 500.20	100	500	2.0	3,488
AFC-100 MİB 600.20	100	600	2.0	3,669

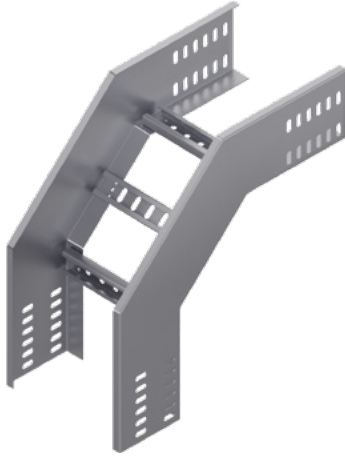
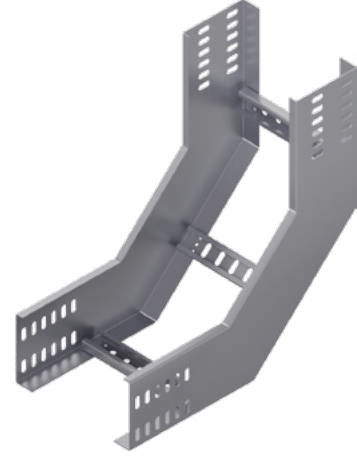

### Dış Bükey Dönüş Modülü

#### 90° Vertical Bend - Outside

Sipariş Kodu Order Code	Yükseklik Height (H) mm	Genişlik Width (AB) mm	Kalınlık Thickness (T) mm	Ağırlık Weight Kg./Ad.
AFC-100 MDB 100.15	100	100	1.5	2,767
AFC-100 MDB 150.15	100	150	1.5	2,873
AFC-100 MDB 200.15	100	200	1.5	2,947
AFC-100 MDB 300.15	100	300	2.0	3,128
AFC-100 MDB 400.20	100	400	2.0	3,312
AFC-100 MDB 500.20	100	500	2.0	3,488
AFC-100 MDB 600.20	100	600	2.0	3,669

### Ek Elemanı

#### Joint Fitting

Sipariş Kodu Order Code	Yükseklik Height (H) mm	Genişlik Width (A) mm	Kalınlık Thickness (T) mm	Ağırlık Weight Kg./Ad.
AFC-100 AE 15.20	100	20	2.0	0,219



**Seviye Deęiřtirme Elemanı**  
Level Change Unit

Sipariř Kodu Order Code	Yükseklik Height (H) mm	Geniřlik Width (A) mm	Kalınlık Thickness (T) mm	Aęırlık Weight Kg./Tk.
AFC-100 SD 15.20	75	20	2.0	0,686

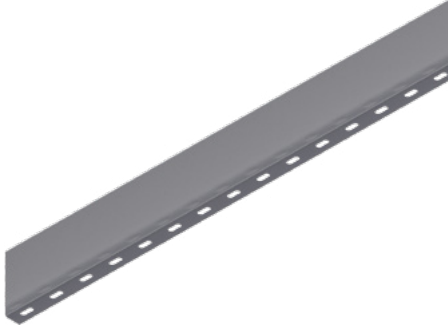

**Separatör**  
Seperator

Sipariř Kodu Order Code	Yükseklik Height (H) mm	Geniřlik Width (A) mm	Kalınlık Thickness (T) mm	Aęırlık Weight Kg./m.
AFC-100 SPM 20.15	100	20	1.5	1,217

**Merdiven Sabitleme Elemanı**  
Ladder Fixing

Sipariř Kodu Order Code	Geniřlik Width (A) mm	Kalınlık Thickness (T) mm	Aęırlık Weight Kg./Ad.
AFC-MKT 25.20	40	2.0	0,033



## **Kablo Merdiveni H 100** **Cable Ladder H 100**

### **İÇİNDEKİLER** **INDEX**

<b>280</b>	<b>Kablo Merdiveni</b> Cable Ladder
<b>281</b>	<b>90° Yatay Dönüş Modülü</b> 90° Horizontal Elbow Module <b>T Dönüş Modülü</b> T Module <b>Dörtlü Bağlantı Modülü</b> + Connection Module
<b>282</b>	<b>İç Bükey Dönüş Modülü</b> 90° Vertical Bend - Inside <b>Dış Bükey Dönüş Modülü</b> 90° Vertical Bend - Outside <b>Ek Elemanı</b> Joint Fitting
<b>283</b>	<b>Seviye Değişirme Elemanı</b> Level Change Unit <b>Separatör</b> Seperator <b>Merdiven Sabitleme Elemanı</b> Ladder Fixing

**Sıcak Daldırma**  
**GHOT Dip Galvanized**



## Sıcak Daldırma Hot Dip Galvanized

### Kablo Merdiveni H100

#### Cable Ladder H100

Sipariş Kodu Order Code	Yükseklik Height (H) mm	Genişlik Width (A) mm	Kalınlık Thickness (T) mm	Ağırlık Weight Kg./m.
AFC-100 M 100.15	100	100	1.5	3,640
AFC-100 M 100.20	100	100	2.0	4,791
AFC-100 M 150.15	100	150	1.5	3,740
AFC-100 M 150.20	100	150	2.0	4,891
AFC-100 M 200.15	100	200	1.5	3,852
AFC-100 M 200.20	100	200	2.0	5,003
AFC-100 M 300.15	100	300	1.5	4,065
AFC-100 M 300.20	100	300	2.0	5,215
AFC-100 M 400.15	100	400	1.5	4,280
AFC-100 M 400.20	100	400	2.0	5,431
AFC-100 M 500.15	100	500	1.5	4,488
AFC-100 M 500.20	100	500	2.0	5,640
AFC-100 M 600.15	100	600	1.5	4,700
AFC-100 M 600.20	100	600	2.0	5,851

#### Örnek Sipariş :

Yükseklik / Height (H) : 100 mm

Genişlik / Width (A) : 100 mm

Kalınlık / Thickness (T) : 1,5 mm

Sıcak Daldırma / Hot Dip Galvanized : SD

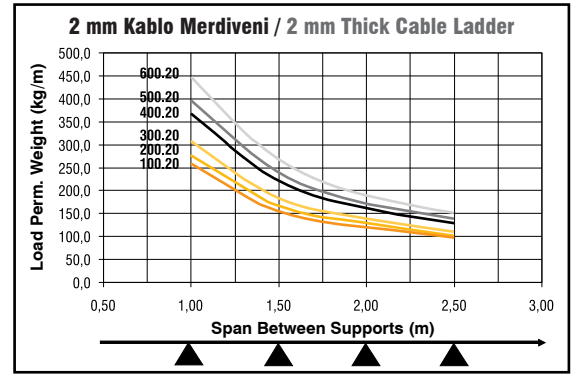
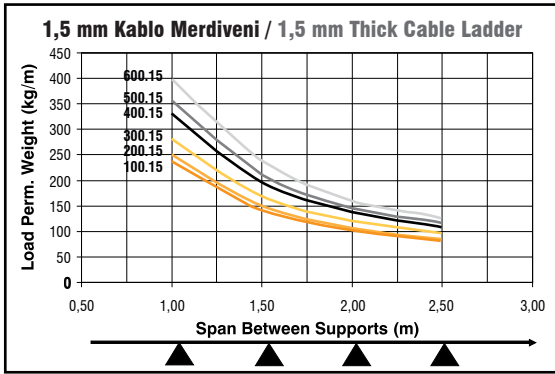
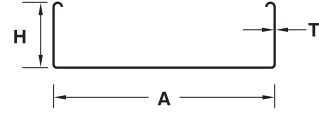
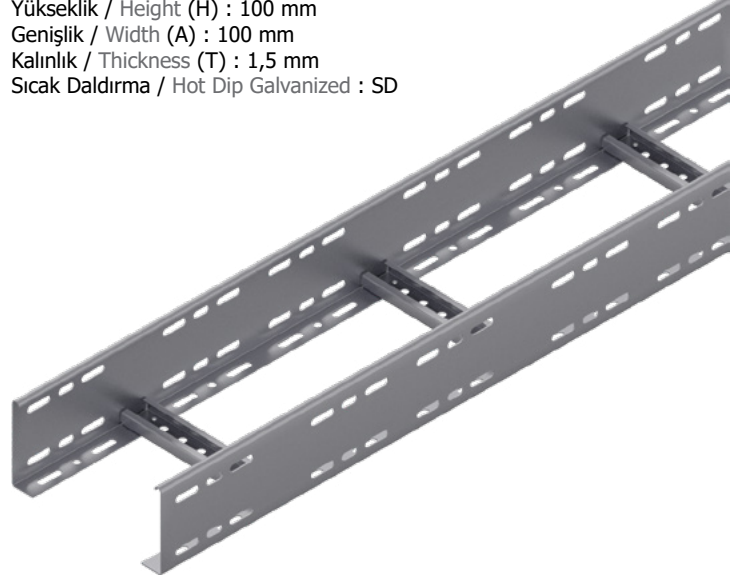

- Malzeme ağırlıkları yaklaşık değerlerdir,  $\pm$  % 10 değişim gösterebilir.  
All material weights are approximate and may vary by +/- 10%.

- Standart uzunluk 2500 ve 3000 mm'dir.  
Standard widths are available in 2500, and 3000 mm.

- Lütfen siparişlerinizde sipariş kodunu bildiriniz.  
Please order by product code.

- Farklı kalınlık ve ölçülerdeki siparişleriniz için lütfen firmamızı arayınız.  
Please contact us for your custom orders.

## 90° Yatay Dönüş Modülü

### 90° Horizontal Elbow Module

Sipariş Kodu Order Code	Yükseklik Height (H) mm	Genişlik Width (AB) mm	Kalınlık Thickness (T) mm	Ağırlık Weight Kg./Ad.
AFC-100 MK 100.15	100	100	1.5	1,740
AFC-100 MK 150.15	100	150	1.5	2,086
AFC-100 MK 200.15	100	200	1.5	2,321
AFC-100 MK 300.20	100	300	2.0	2,903
AFC-100 MK 400.20	100	400	2.0	4,392
AFC-100 MK 500.20	100	500	2.0	5,096
AFC-100 MK 600.20	100	600	2.0	5,687

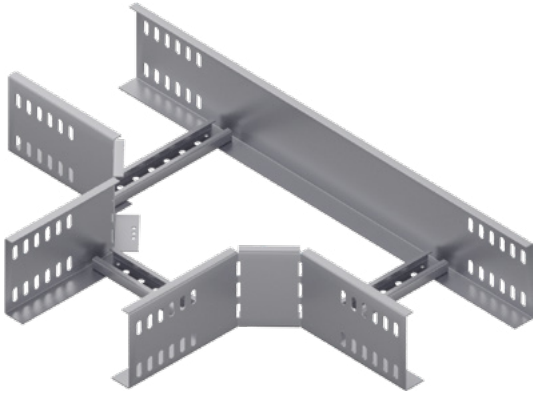
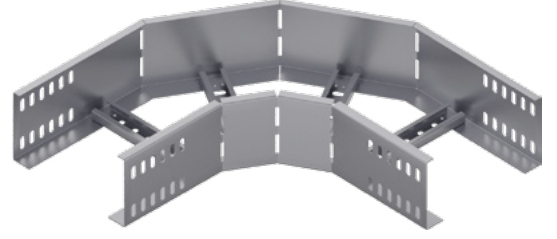

## T Dönüş Modülü

### T Module

Sipariş Kodu Order Code	Yükseklik Height (H) mm	Genişlik Width (ABC) mm	Kalınlık Thickness (T) mm	Ağırlık Weight Kg./Ad.
AFC-100 MT 100.15	100	100	1.5	2,553
AFC-100 MT 150.15	100	150	1.5	2,867
AFC-100 MT 200.15	100	200	1.5	3,127
AFC-100 MT 300.20	100	300	2.0	3,764
AFC-100 MT 400.20	100	400	2.0	5,266
AFC-100 MT 500.20	100	500	2.0	5,906
AFC-100 MT 600.20	100	600	2.0	6,549

## Dörtlü Bağlantı Modülü

### + Connection Module

Sipariş Kodu Order Code	Yükseklik Height (H) mm	Genişlik Width (ABCD) mm	Kalınlık Thickness (T) mm	Ağırlık Weight Kg./Ad.
AFC-100 MD 100.15	100	100	1.5	2,610
AFC-100 MD 150.15	100	150	1.5	2,837
AFC-100 MD 200.15	100	200	1.5	3,002
AFC-100 MD 300.20	100	300	2.0	3,400
AFC-100 MD 400.20	100	400	2.0	4,507
AFC-100 MD 500.20	100	500	2.0	4,898
AFC-100 MD 600.20	100	600	2.0	5,295

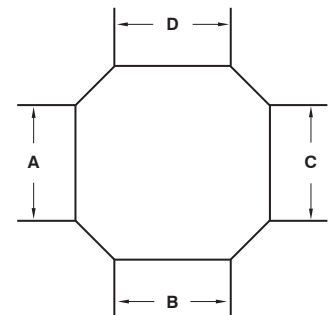
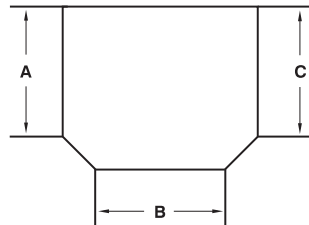
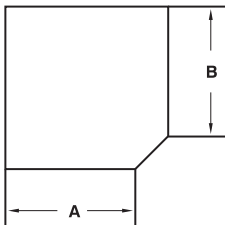
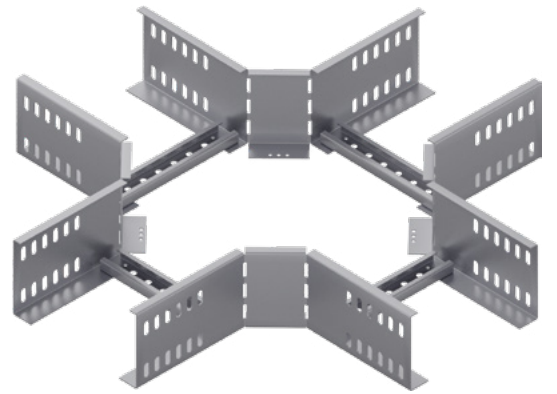





## Sıcak Daldırma Hot Dip Galvanized

### İç Bükey Dönüş Modülü

#### 90° Vertical Bend - Inside

Sipariş Kodu Order Code	Yükseklik Height (H) mm	Genişlik Width (AB) mm	Kalınlık Thickness (T) mm	Ağırlık Weight Kg./Ad.
AFC-100 MİB 100.15	100	100	1.5	3,044
AFC-100 MİB 150.15	100	150	1.5	3,160
AFC-100 MİB 200.15	100	200	1.5	3,242
AFC-100 MİB 300.15	100	300	2.0	3,441
AFC-100 MİB 400.20	100	400	2.0	3,643
AFC-100 MİB 500.20	100	500	2.0	3,837
AFC-100 MİB 600.20	100	600	2.0	4,036

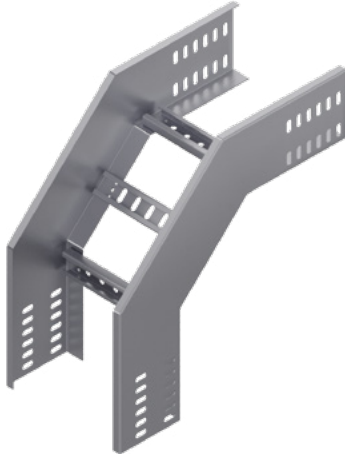
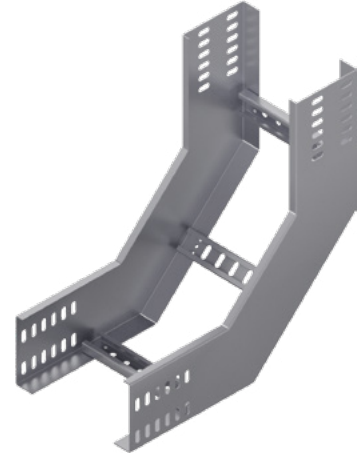

### Dış Bükey Dönüş Modülü

#### 90° Vertical Bend - Outside

Sipariş Kodu Order Code	Yükseklik Height (H) mm	Genişlik Width (AB) mm	Kalınlık Thickness (T) mm	Ağırlık Weight Kg./Ad.
AFC-100 MDB 100.15	100	100	1.5	3,044
AFC-100 MDB 150.15	100	150	1.5	3,160
AFC-100 MDB 200.15	100	200	1.5	3,242
AFC-100 MDB 300.15	100	300	2.0	3,441
AFC-100 MDB 400.20	100	400	2.0	3,643
AFC-100 MDB 500.20	100	500	2.0	3,837
AFC-100 MDB 600.20	100	600	2.0	4,036

### Ek Elemanı

#### Joint Fitting

Sipariş Kodu Order Code	Yükseklik Height (H) mm	Genişlik Width (A) mm	Kalınlık Thickness (T) mm	Ağırlık Weight Kg./Ad.
AFC-100 AE 15.20	100	20	2.0	0,241



**Seviye Değişirme Elemanı**  
Level Change Unit

Sipariş Kodu Order Code	Yükseklik Height (H) mm	Genişlik Width (A) mm	Kalınlık Thickness (T) mm	Ağırlık Weight Kg./Tk.
AFC-100 SD 15.20	75	20	2.0	0,754

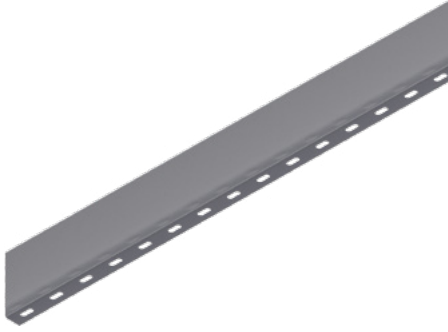

**Separatör**  
Seperator

Sipariş Kodu Order Code	Yükseklik Height (H) mm	Genişlik Width (A) mm	Kalınlık Thickness (T) mm	Ağırlık Weight Kg./m.
AFC-100 SPM 20.15	100	20	1.5	1,338

**Merdiven Sabitleme Elemanı**  
Ladder Fixing

Sipariş Kodu Order Code	Genişlik Width (A) mm	Kalınlık Thickness (T) mm	Ağırlık Weight Kg./Ad.
AFC-MKT 25.20	40	2.0	0,036

